

TECHNICAL BULLETIN

TEESING

WE MAKE YOUR TECHNOLOGY WORK

mott
MISSION CRITICAL PRECISION

CATALYST FILTRATION

for the Chemical Processing Industry using Mott LSI Backwash Filter Media

By Louise Stange, Research & Applications Specialist, Mott Corporation

CATALYST FILTRATION

Mott HyPulse® Filters for Catalyst Separation**Summary**

Catalysts, such as nickel, platinum, rhodium and palladium, are used extensively in preparing specialty chemical products, pharmaceutical and agricultural chemicals. These catalysts often need to be removed or recycled from the process stream. Filtration is one method that can be used for both purifying liquid ingredients and recovering the catalyst solids for reuse or recycle. Filtration technology plays an important role in today's industry trends that include end user demand for finer filtration, more stringent safety regulations and the need to reduce environmental impact – including material recycle and waste disposal and regeneration.

Challenge

Filtration equipment for catalyst separation needs to hold up to aggressive process conditions that can include high temperatures and pressures, as well as aggressive or corrosive chemistry. Filtration and recovery of expensive or hazardous catalysts require filtration systems that are specially designed to reduce atmospheric exposure and minimize material handling and loss (spillage) of catalyst material.

Sintered metal candle filters have been used successfully for many years in the filtration of nickel and precious metal catalysts used for various chemical processes. Filtration using sintered metal media typically does not require gradient filtration steps – providing clear filtrate in a single pass. The closed-loop system reduces exposure to atmospheric conditions which can affect product quality and catalyst life. Residual mother liquor or solvent can be removed without opening the filter assembly. The filter media is cleaned in-situ using an automated backwash cycle. Sintered metal filter media can be cleaned and re-used – in many cases for a number of years.



*3D rendering of
Mott HyPulse LSI Filter*

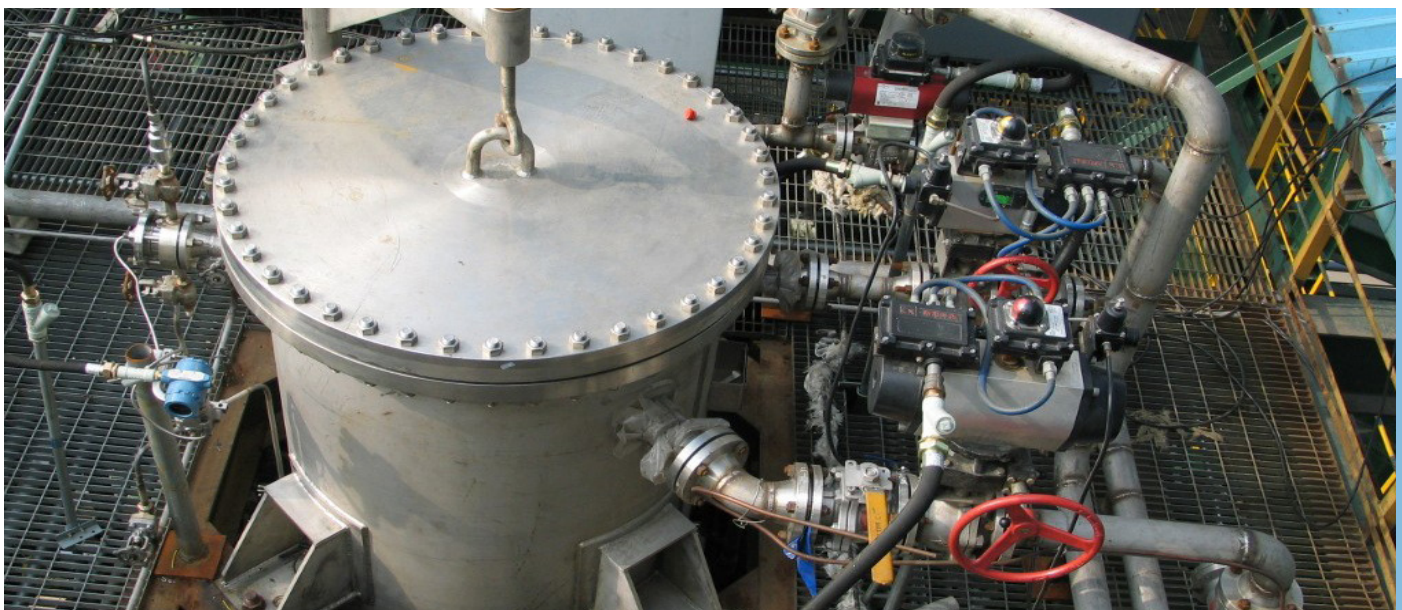

Mott LSI Filter Installed in Catalytic Process

Achieve Optimum Filtration with Mott HyPulse Filters

The selection of filter media and filtration systems involves choosing the optimum filtration media to perform solids/liquid separation reliably and safely under plant-specific environmental conditions. The Mott team of highly experienced engineers is ready to evaluate your industry challenges and offer new and practical solutions to help you improve productivity while meeting strict environmental requirements. Mott offers continued support from the early stages of laboratory and pilot plant studies to the scale-up and commissioning of the commercial filter installation.

The Mott HyPulse catalyst separation technology allows for an automatic recycling of catalyst into the reactor and allows for spent catalyst discharge into a drum for re-processing. Filter elements are easily cleaned of catalyst cake by using a gas assisted liquid discharge backwash. It is a quick and simple operation with no requirements for scrubbing, scraping or rotating of filter elements. There are significant cost savings associated with working with hazardous materials and reduced hazardous waste handling and production – as disposable media can contribute up to 70% of the volume of hazardous wastes generated in the process. In addition, backwashable candle filter systems have a smaller footprint than traditional plate and frame filters.



Mott Dual LSI Filter System

Advantages of a HyPulse Filter

- Completely closed system
- No rotating parts
- Single pass filtration
- Catalyst recycle / removal
- Reduce fire hazards
- Quick and efficient backwash
- Effective filtration performance
- No catalyst breakthrough

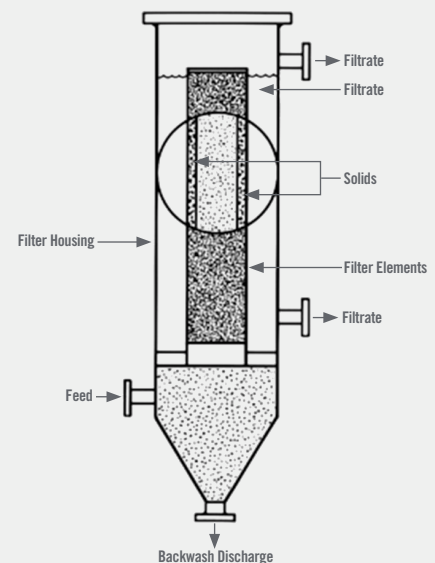

The LSI configuration is more efficient than outside-in filtration as there is less heel, no bridging, minimal loss of filtrate, smaller footprint and easier discharge of solids.

Elements can be selected based on solids holding capacity, therefore optimizing packing density.

Using the upper filtrate outlet assures filter cake deposition through the full length of the element and an effective backwash.

Using the lower filtrate outlet allows displacing of the filtered liquid from the shell with gas, increasing product yield and producing a higher concentration slurry backwash.

Mott Testing Laboratory

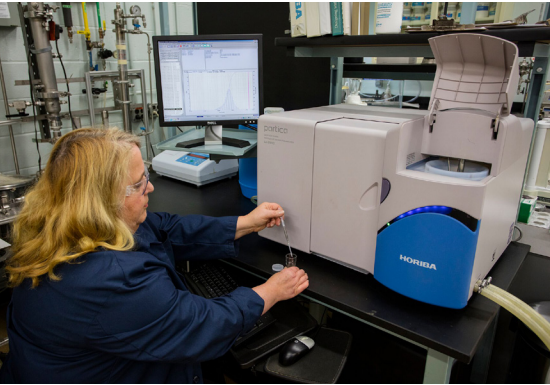

Material Characterization Lab Services Center in Farmington, CT.

Mott Corporation offers one of the best-equipped filtration testing laboratories in the industry today. The combination of leading-edge equipment and highly experienced personnel allows for comprehensive, in-depth application analysis and reliable process operating parameter recommendations.

Testing is available for both liquid/solids and gas/solids applications. Testing is critical for confirming media selection and for preliminary filter sizing. Although applications may appear similar, there can be subtle differences that will significantly influence the optimum process operating parameters. Variability in operating temperature, solids content and particle size, and distribution of solids are just a few examples. Information obtained from feasibility and pilot scale testing includes:

- Obtain sizing data for scale-up and verify operation conditions.
- Introduce and train operating personnel in filter operation.
- Challenge the filter with variations in the process conditions.
- Obtain long term operating information for cleaning and maintenance scheduling.
- Evaluate the effect of extended operation on different media.
- Materials compatibility testing.

Mott Corporation has a long-established program for feasibility testing on pre-qualified liquid/solids and gas/solids separations applications. A comprehensive test report including initial filter design recommendations is furnished for customer review. Remaining unfiltered feed, collected solids and liquid filtrate samples are returned to the customer after the testing is completed for any further analysis and for disposal.

GET THE DATA YOU NEED

- Catalyst Recovery/Removal Rates
- Particle Size Distribution (PSD)
- Feeds Solids Concentration
- Feed Viscosity
- Filtrate Clarity - PPM or Turbidity (NTU)
- Solids Cake Characteristics
- Flux Rates
- Pressure Drop Analysis
- Backwash Characterization
- Backpulse Characterization

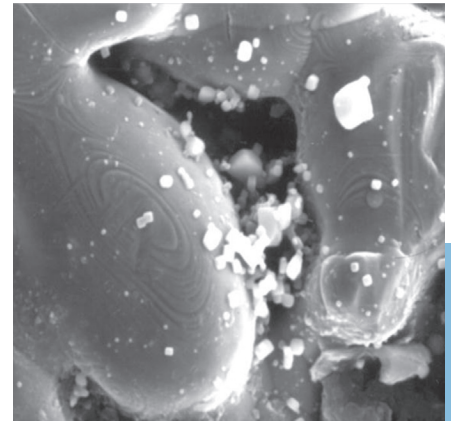

Case Study: Catalyst Filtration Testing at Mott Laboratory

Filtration Comparison of Palladium Catalyst from Two Different Catalyst Suppliers

If your process requires evaluation of catalysts from different suppliers or catalyst chemistry – in most cases these changes will affect the process performance of your filtration system. Catalyst particle size, shape and density will affect the filtration cycle time, rate of rise in pressure, flow rate through the filter and downstream filtrate quality.

Particle size analyses of two different Palladium catalysts were evaluated using a Horiba LA-950 laser scattering distribution analyzer. The Pd-on-C catalyst material showed a significant number of particulate fines compared to the Pd-on-Al material as indicated in the histograms below. The results from the Horiba analysis are summarized in Table #1.

Although both of these materials are Palladium catalysts, their particle size distributions differ, particularly with respect to particulate fines. One could imagine that a filter designed exclusively for the Pd-on-Al material may have difficulty with the fines in the Pd-on-C material. In this case, engineers can design for the envelope of both materials, ensuring successful and versatile operation of the filter.

The next page presents further details of both Palladium catalysts.

(continued on page 6)

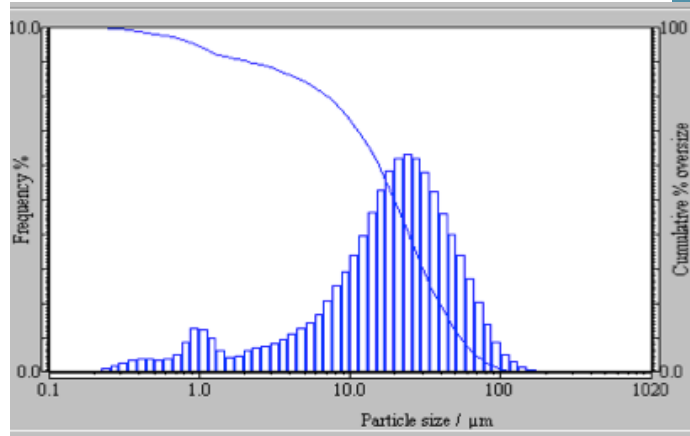

Horiba Particle size distribution comparison of 5% Pd-on-C (top) to 2% Pd-on-Al (bottom)

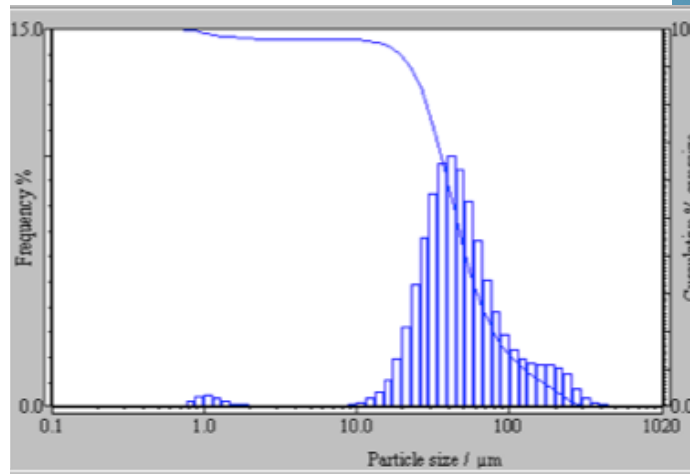

Table 1

Summary Horiba Particle Size Distribution		
Size based on Volume %	5% Palladium/ Carbon	2% Palladium/ Alumina
Particle Size Range, μm	0.26 – 152	0.77 – 394
90% Over, μm	2.25	22.6
10% Over, μm	55.05	129.35
Mean Size, μm	24.45	62.7

Case Study: Catalyst Filtration Testing at Mott Laboratory

(continued from page 5)

Laboratory examination of two types of Palladium catalysts were evaluated optically using a scanning electron microscope (SEM). The photomicrographs below show a completely different size and shape of the two Palladium catalysts being filtered. Along with size distribution, particle shape is an important characteristic to understand in media grade selection.

Feasibility testing used the Mott 70 mm disc test fixture for the filtration of two batches of 600 ppm Palladium catalyst in polyalpha olefin (PAO) using Mott Grade 1 media. The feed slurry was filtered as a batch and the cycle time was recorded. Filtrate quality was analyzed using Gravimetric analysis using Durapore 0.45 -micron filter paper. The results are summarized in Table 2.

Test results indicate the Pd-on-Al catalyst material is comparable to the Pd-on-C catalyst regarding flow rate and filtrate quality. The Pd-on-Al material had a lower pressure drop across the media. The overall cake thickness of the Pd-on-Al sample may increase because of the lower pressure drop across the media. The Pd-on-Al sample can be filtered using the existing filtration system with Mott Grade 1 media. In both tests filtrate quality was optically clear and measured less than 1 ppm.

The results from this case study provided quantitative data against which an efficient filtration system can be designed. This path mitigates risk and cost to the end user as the system is designed based on actual data rather than conservative assumptions.

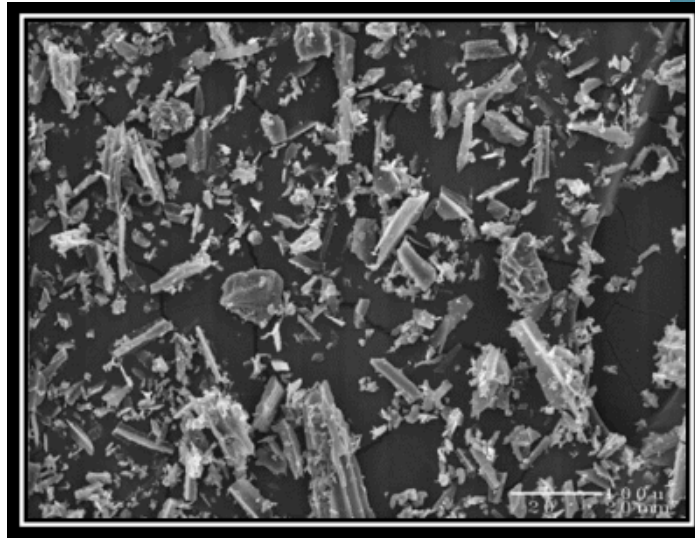

SEM photomicrograph comparison of 5% Pd-on-C (top) and 2% Pd-on-Al (bottom)

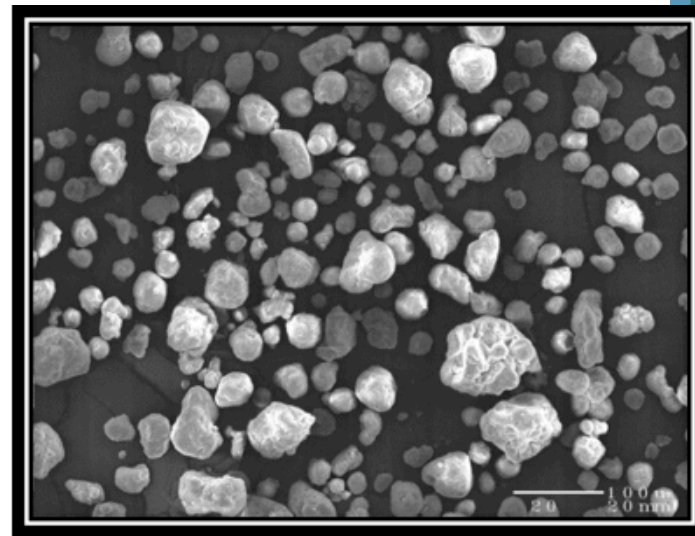

Table 2

Summary Disc Filter Testing		
Test	1	2
Sample	Pd-on-C	Pd-on-Al
Cycle Time, min	18.3	25.0
Average Flux, gpm/ft ²	0.42	0.32
Terminal Pressure Drop, psi	6	3
Cake Backwashed	Yes	Yes
Filtrate Quality, PPM	0.268	0.413

About Mott

Our team of highly skilled professionals understands the importance of designing, engineering, manufacturing and servicing the best products in the industry, and providing unparalleled technical expertise to our customers.

For more than half a century, Mott has earned a reputation for ironclad reliability, unparalleled applications expertise and attention to customer service. Today, we operate two facilities in the United States and partner with a global network of distributors that attend to our customers' needs in all corners of the world.

Materials

We sinter components from a variety of metals and alloys to meet temperature and corrosion resistance requirements.

- Stainless Steel 316L, 304L, 310, 347 and 430
- Hastelloy® C-276, C-22, X, N, B and B2
- Inconel® 600, 625 and 690
- Nickel 200 and Monel® 400 (70 Ni-30 Cu)
- Titanium
- Alloy 20
- Many others

Optimized, not Standardized

Feasibility Testing

Collaborate with Mott's engineers as they test your sample in our state-of-the-art lab, to determine the optimal filter media and sizes for your unique application.

Design Optimization

Rely on our engineering expertise – amassed during more than 600 global installations – to optimize your filtration system.

Pilot Testing

Install a pilot unit in your facility and put our filtration system to the test under your unique conditions.

Installation Support

Depend on our engineers to work with your installation professionals during the implementation of your custom Mott filtration system.

Post-Installation Support

Turn to our experts to address any questions or issues that may arise anytime following installation.

TEESING

WE MAKE YOUR TECHNOLOGY WORK

mott
MISSION CRITICAL PRECISION

MOTTCORP.COM | 860-747-6333 | 84 SPRING LANE | FARMINGTON CT 06032 | ISO 9001 CERTIFIED FFT 0118



© 2018 Mott Corporation